

# Le Défi des CROCOS



Activités U4 / U5 Fevrier 2023



Entoure tout ce qui est rouge.



Colorie l'animal le plus grand.

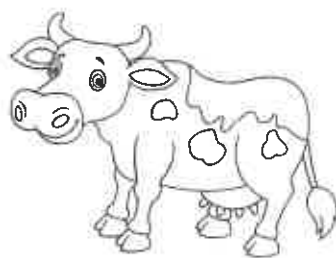
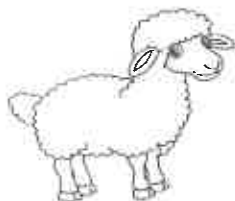

Relie chaque main au nombre d'animaux correspondant.

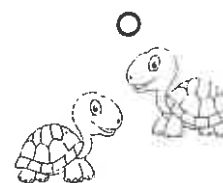
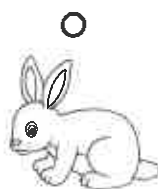
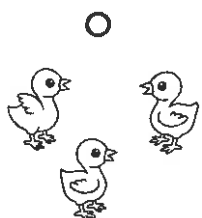

Comment appelle-t-on les bébés de la cane.  
Colorie-les en jaune.

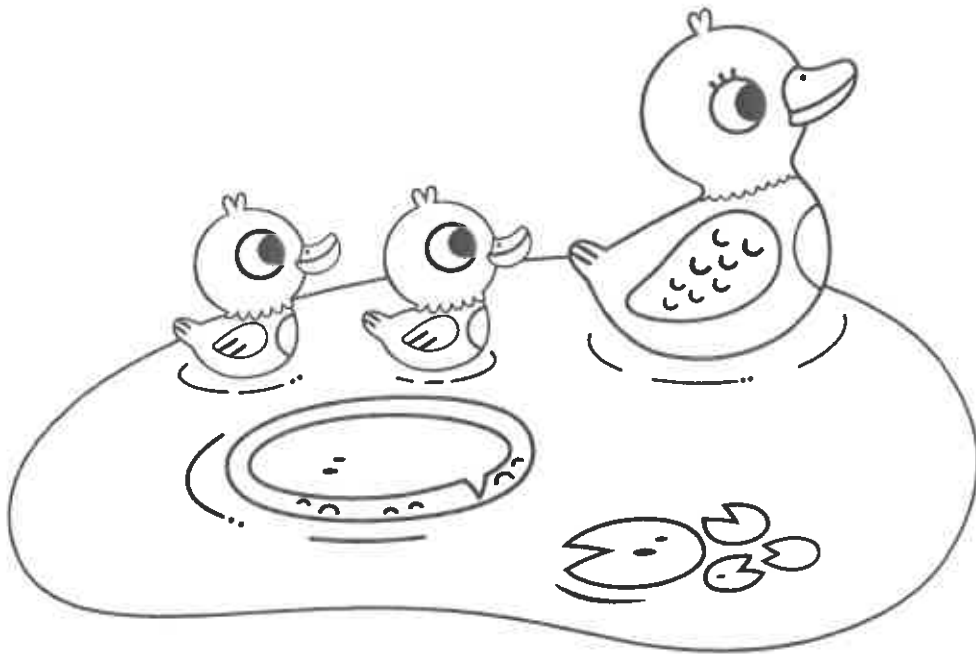

Où dort le chien ?  
Entoure le plus petit chien.



Repasse sur les bulles et colorie les ronds sur les poissons.

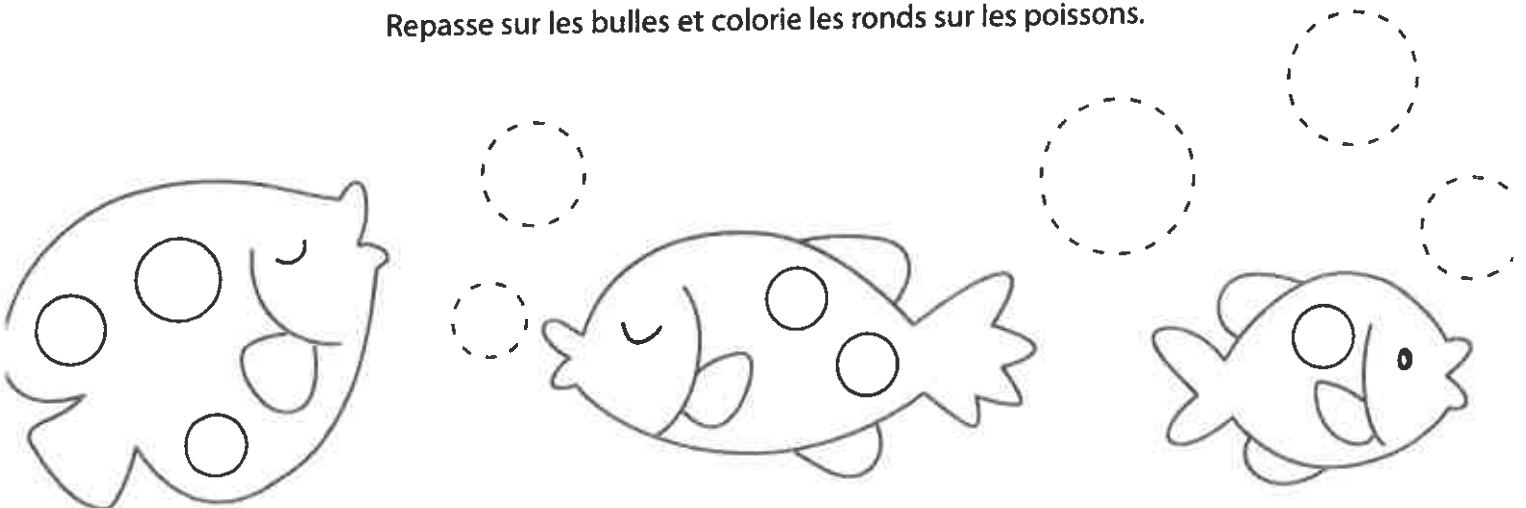

Colorie les wagons en suivant l'ordre des couleurs.  
Connais-tu les deux couleurs des wagons.

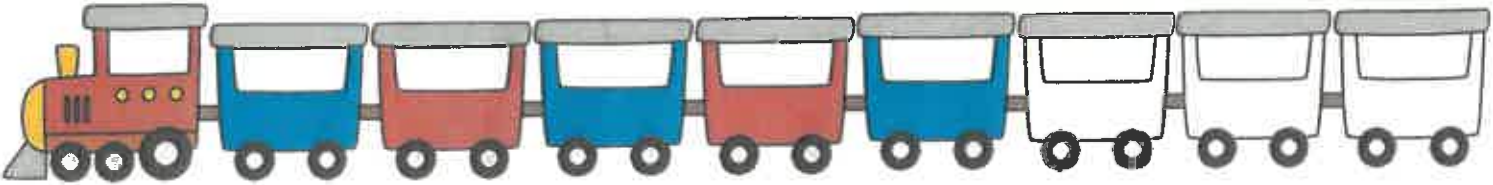

Entoure les animaux à 2 pattes.

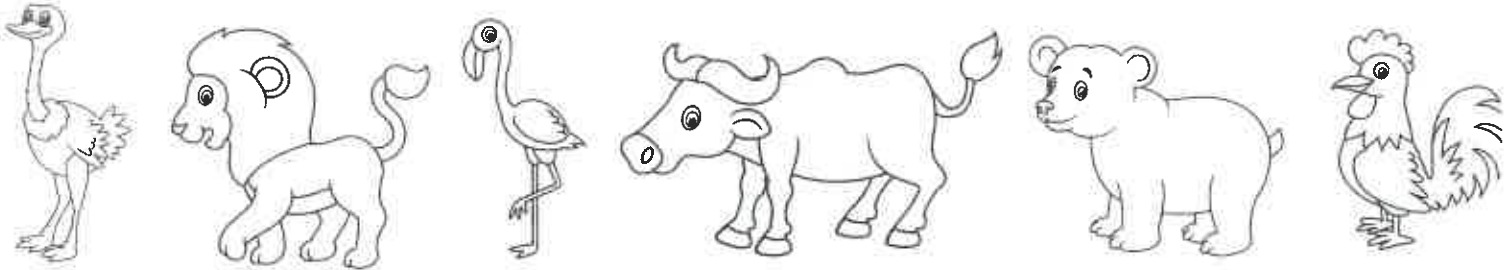

Quel temps fait-il ?



1



2

Entoure ensemble les légumes identiques.  
Combien de légumes comptes-tu dans chaque groupe ?

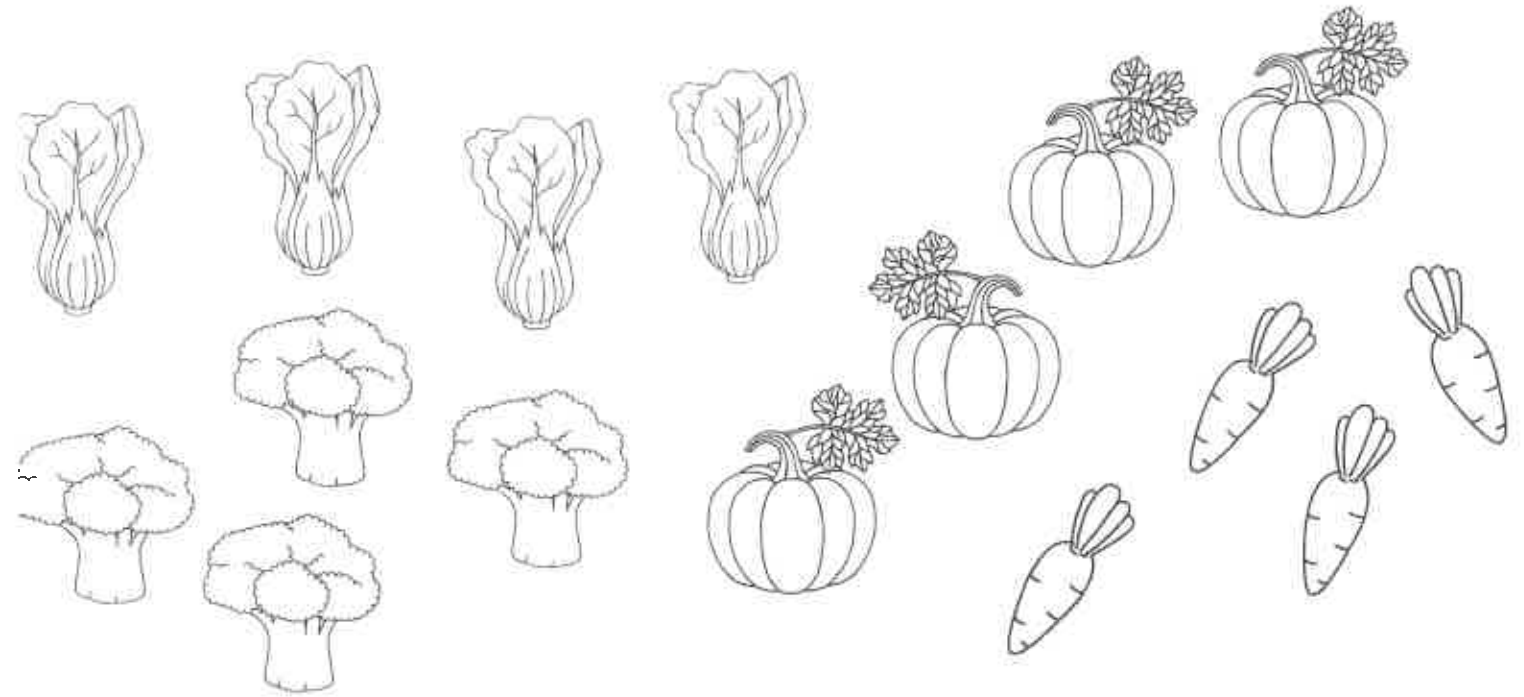

Colorie les aliments qui ne sont pas des légumes.

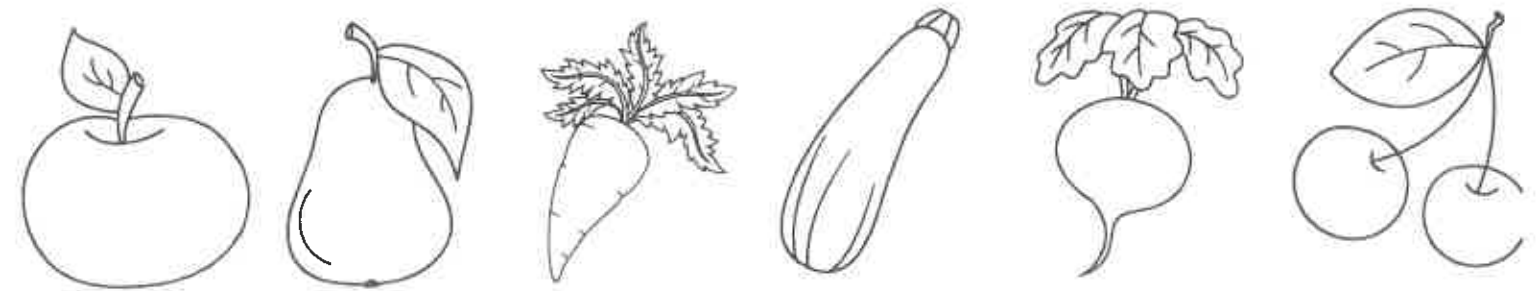

Repasse sur les pointillés et complète la ligne.

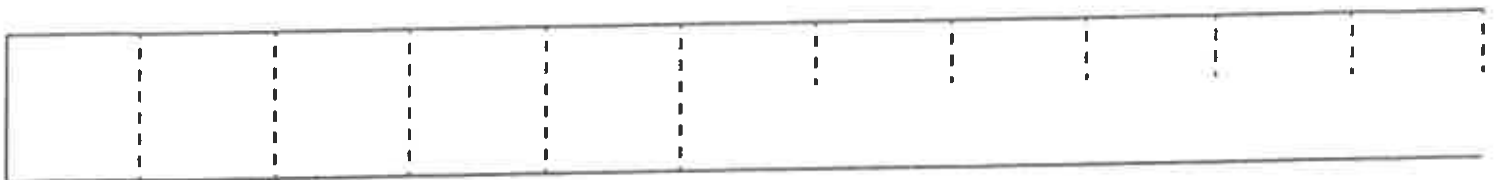

Colorie le carré en bleu.

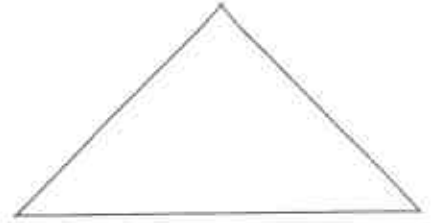
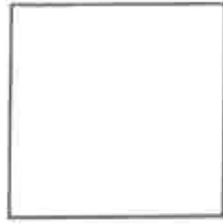
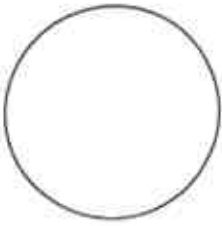

Dessine à côté de chaque poule le nombre d'œufs indiqué sur chacune d'elles. 



Entoure le chien qui est dans la niche.



Colorie le triangle en vert.

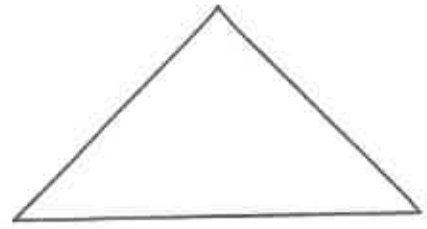
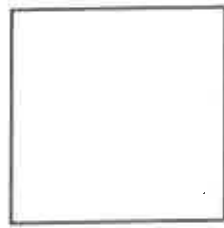
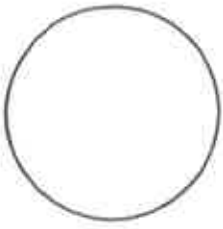

Aide maman cane à rejoindre ses canetons. Plusieurs chemins ne sont pas accessibles.

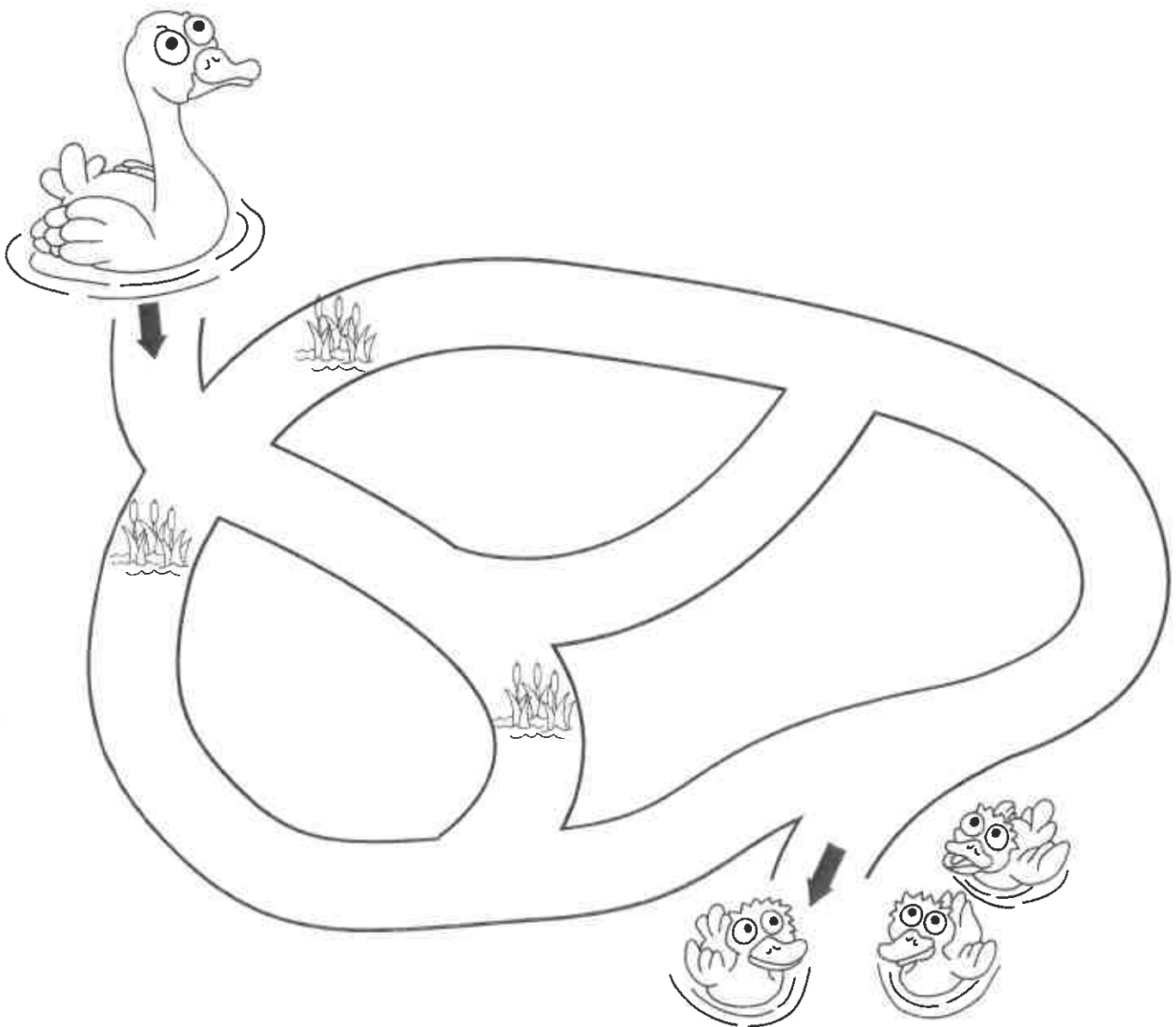

Observe les deux animaux sur la balance.  
Entoure en rouge le plus lourd et en bleu le plus léger.

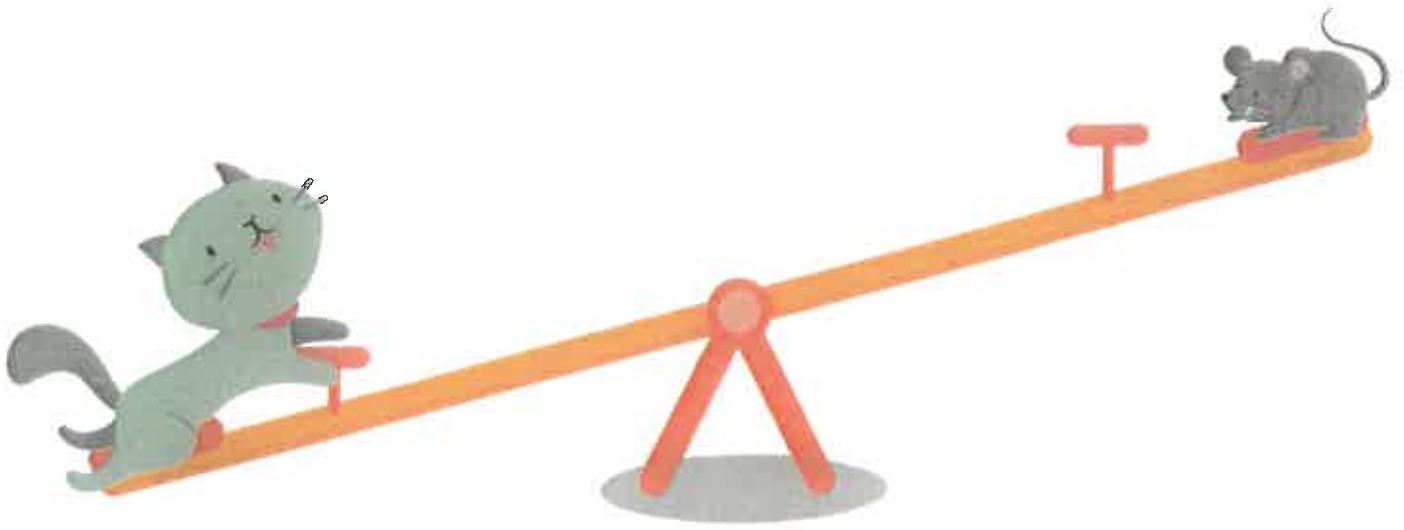

Relie les points en respectant la suite de 1 à 5 pour compléter les dessins.

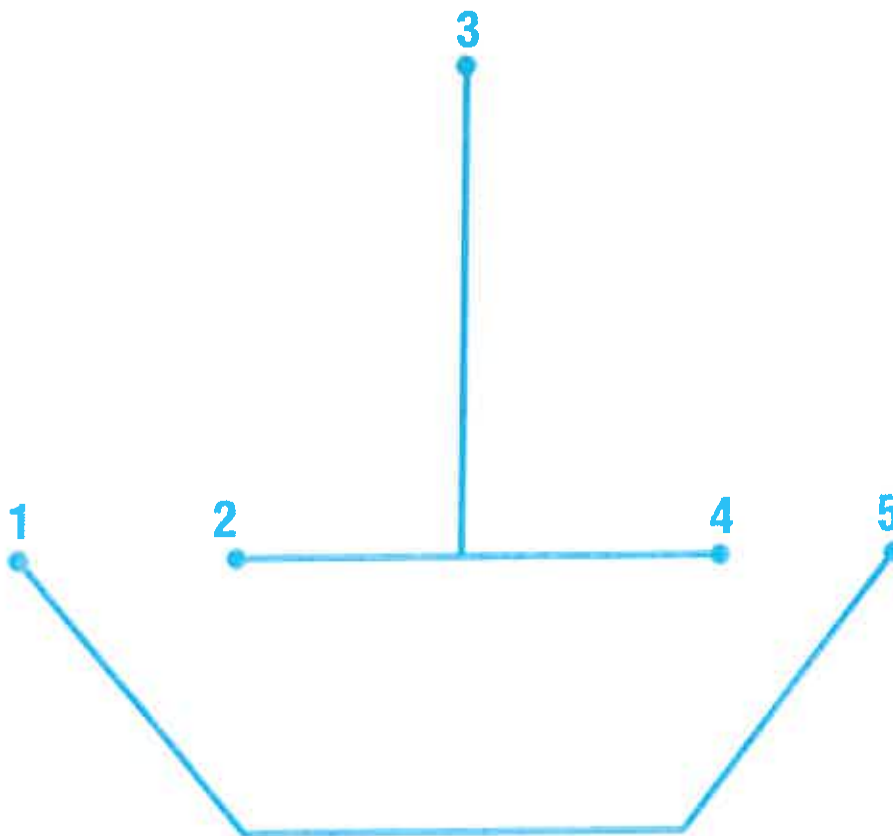



Colorie l'oiseau qui est sous l'arbre.

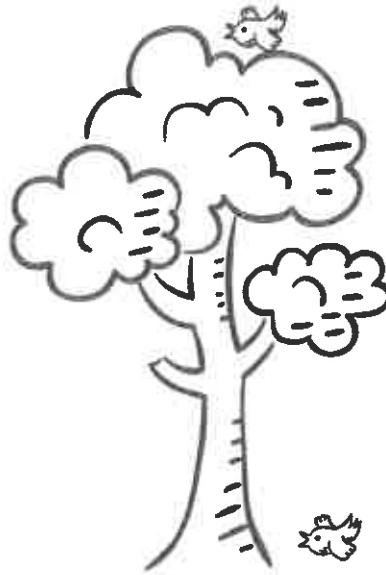

Colorie le dessin dont le nom commence par la lettre **A**.

AVION



ABEILLE

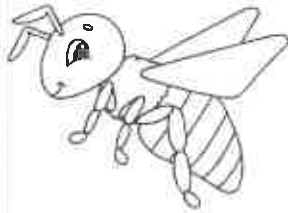

MOUTON

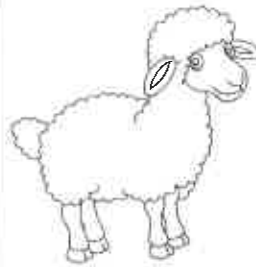

ARBRE

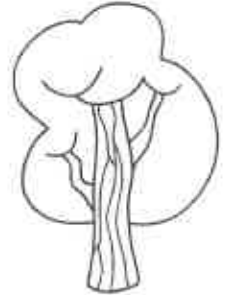

Colorie en suivant le code.

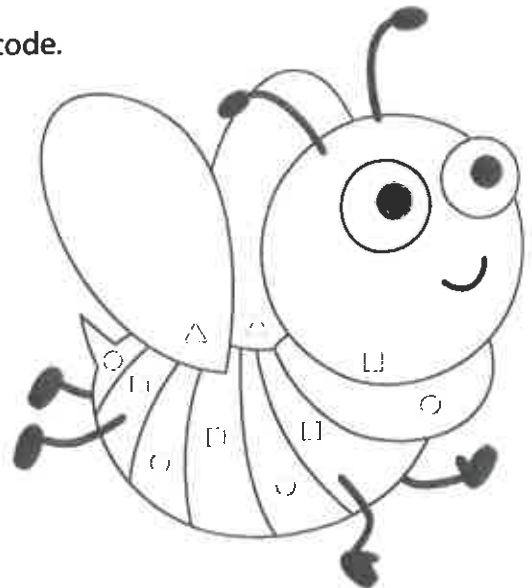

Entoure **4** différences entre les deux dessins.



Entoure le chien qui est derrière la boîte.



Il fait **nuit**. Colorie en bleu la pastille ronde de l'image qui correspond.

